

SWAC3021

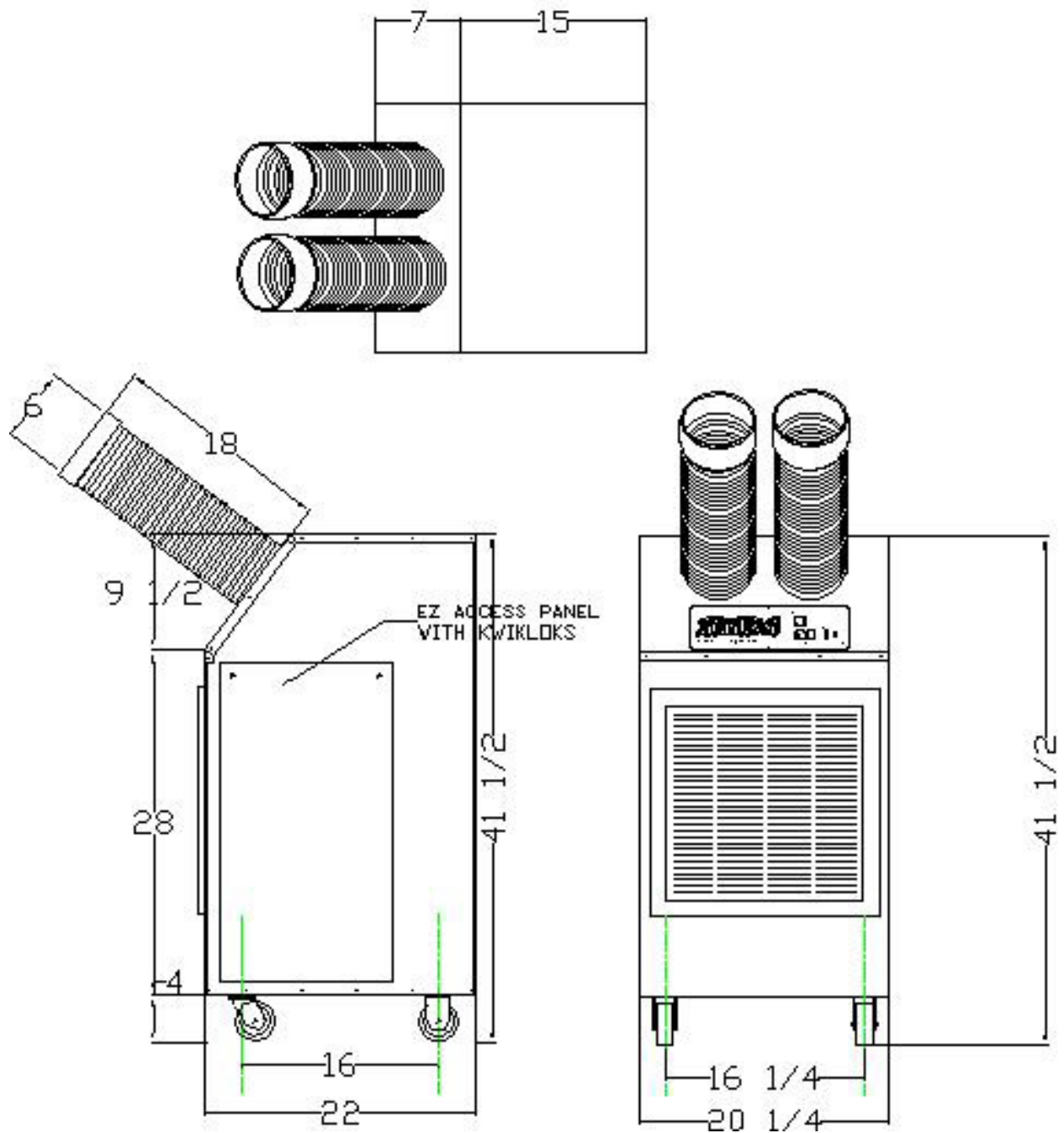

COOLING CAPACITY		
	BTU/hr @ 95°F at 60% RH	29,500 (2.5 Ton)
COMPRESSOR DATA		
	Compressor Type	Hermetic Recip.
	Operating Temperatures	60°F-110°F 50% RH
FAN DATA		
EVAPORATOR		
	Fan Type (Centrifigul)	Direct Drive
	Air Flow (CFM) / Speeds	850
	Supply Air Data	2 -6"x18"
	Supply Air Chute Max. Length	25'
	Max. Ext. Static	.25
	Motor HP	1/3
WATER FLOW DATA		
	Flow Regulating Valve	Automatic
	Inlet Water 85°F-95° F Exit (GPM)	7.5
	Inlet Water 75°F-95° F Exit (GPM)	7.5
	Inlet Water 65°F-95° F Exit (GPM)	2.5
	Inlet Water 55°F-95° F Exit (GPM)	2.0
ELECTRICAL DATA		
	Power Supply (Volts)	230-1Ø
	Current Consumption (Amps)	11.5
	Power Consumption (KW)	2.6
	Maximum Circuit Breaker (Amps)	20
	Min. Circuit Ampacity (Amps)	14.45
	Min/Max Voltage	195-250
	Power Cord Guage/Length	12AWG/6'
	Plug Configuration	NEMA 6-20
DIMENSIONAL DATA		
	Width (Inches)	20.25"
	Depth (Inches)	22"
	Height (Inches)	41.5"
	Weight (Pounds)	208
	Shipping Weight (Pounds)	238
SAFETY DEVICE DATA		
	Compressor Overload	Internal
	Fan Motor Overload	Automatic Internal
	Evaporator Freeze-up	Hot Gas Bypass
	High Pressure	Manual
	Low Pressure	Automatic
	Compressor Short Cycle	Yes
	Automatic Restart	Yes
	Thermostat	Digital
	Condensate Pump Overflow	Yes
	Condensate Tank Overflow	Yes